











40 min

Ax8 	Bx10 	Cx18 	Dx18 	Ex2 	Fx2 
Gx22  Ø10x50	Hx14  Ø4x17	Ix16  Ø4x55	Jx1 	Kx1  SW 6	



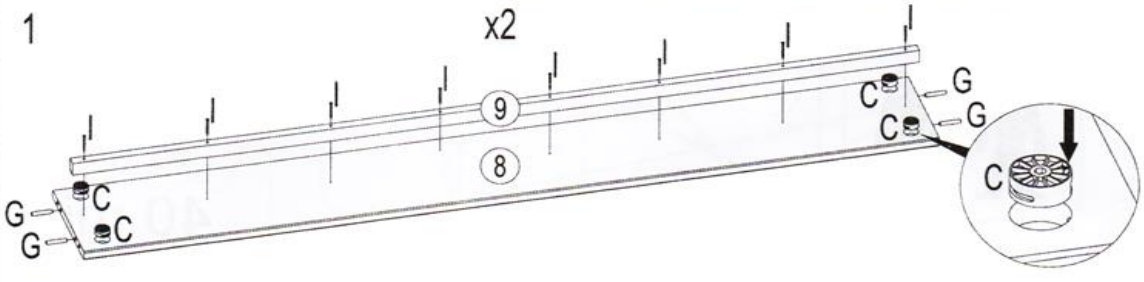
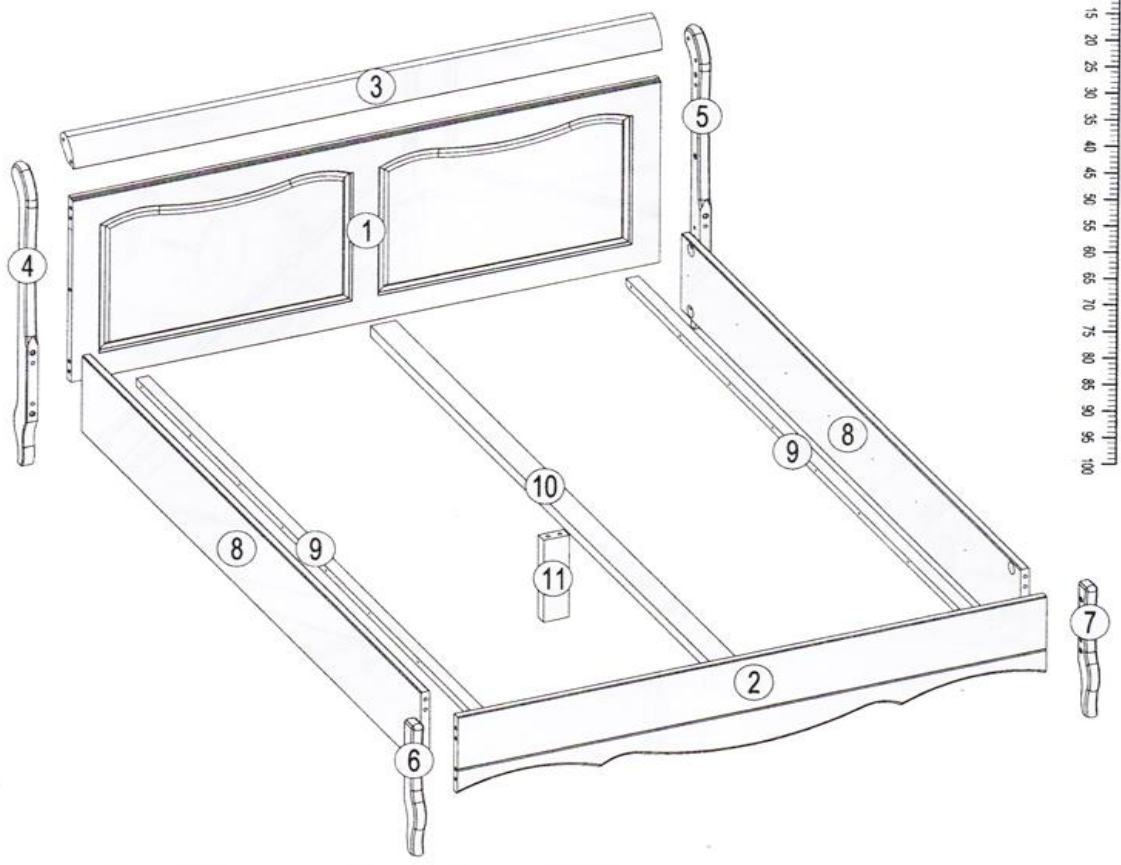
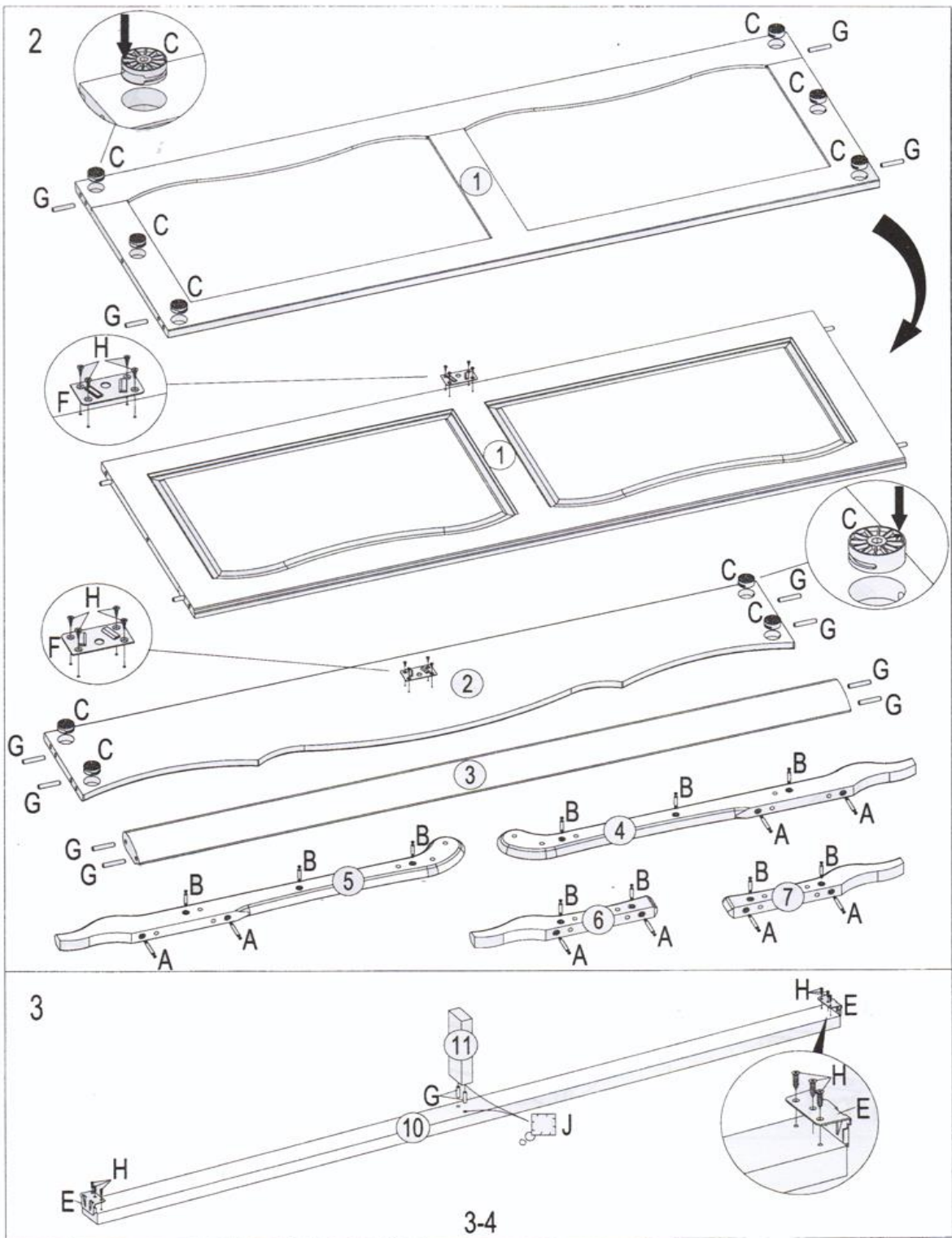

4

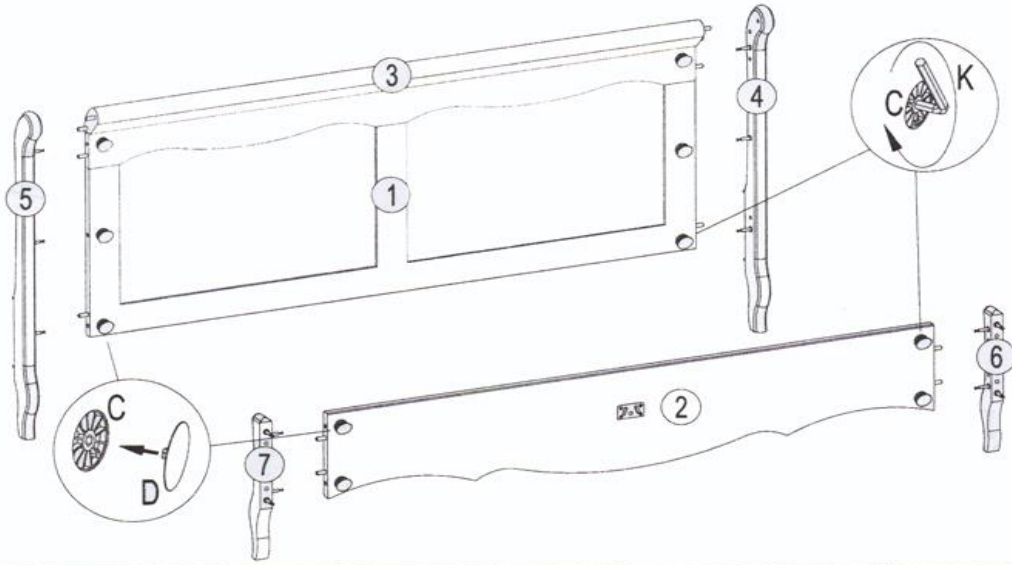

5

