

60 min

**EAC**

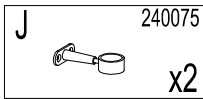

Nº	Size/MaB (mm)	Qty	✓	Nº	Size/MaB (mm)	Qty	✓
1U	2100x686x24	1		3U	599x25x25	1	
2U	786x240x30	1		4U	78x32x32	4	

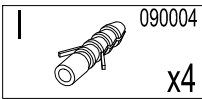
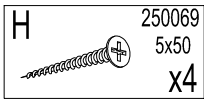
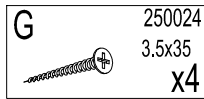
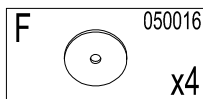
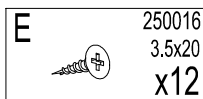
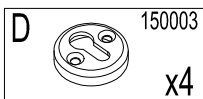
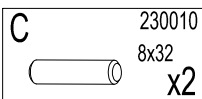
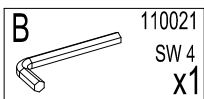
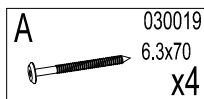
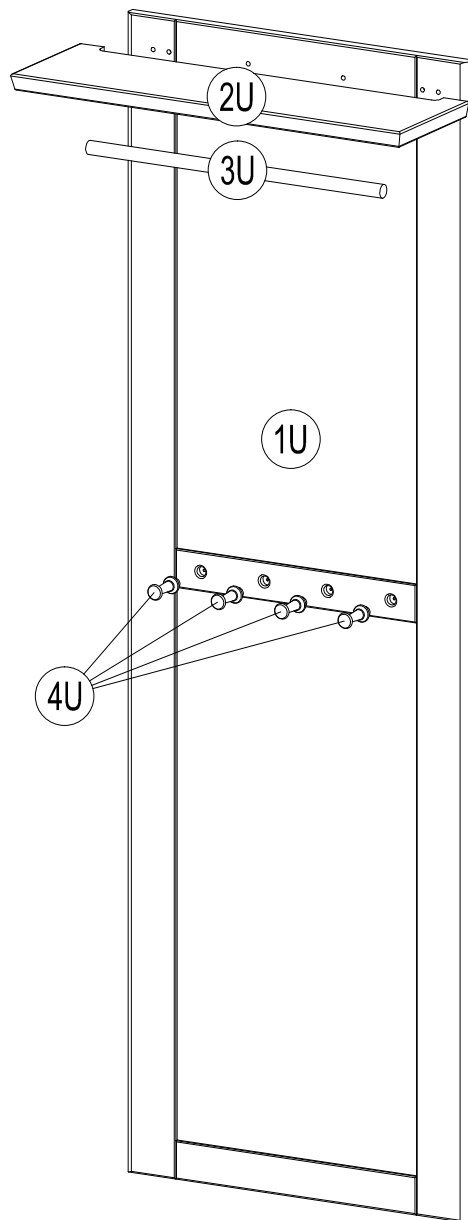