

Грета

Шкаф книжный №8, №9, №10

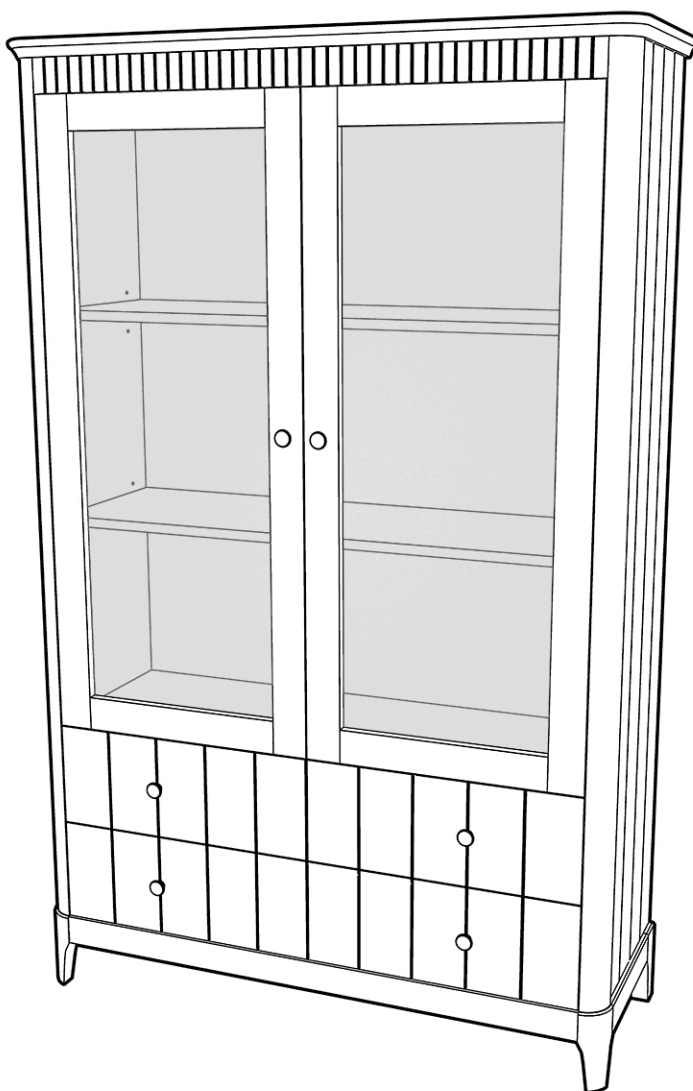

 **TIMBERICA**

- RU** Инструкция по сборке
- EN** Assembly instruction
- FI** Koontaohje



1006
76



2002
6



1038
52



1097
36



1096
36

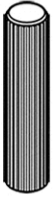

1004
10



1013
4

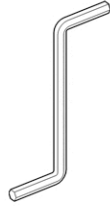

1034
1

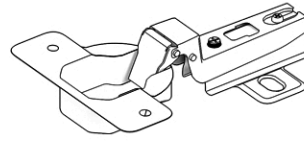

1024
4



1040
8



1039
20



1008
8

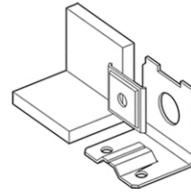

1099
2

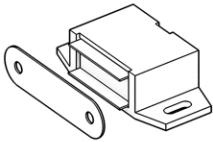

1042
2

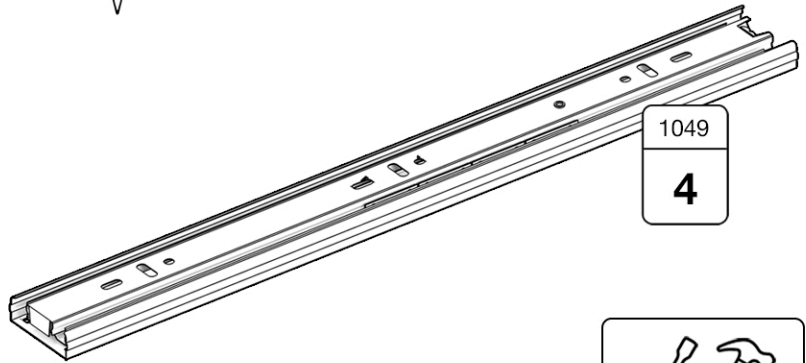

1049
4

