

Грета

Шкаф книжный №6

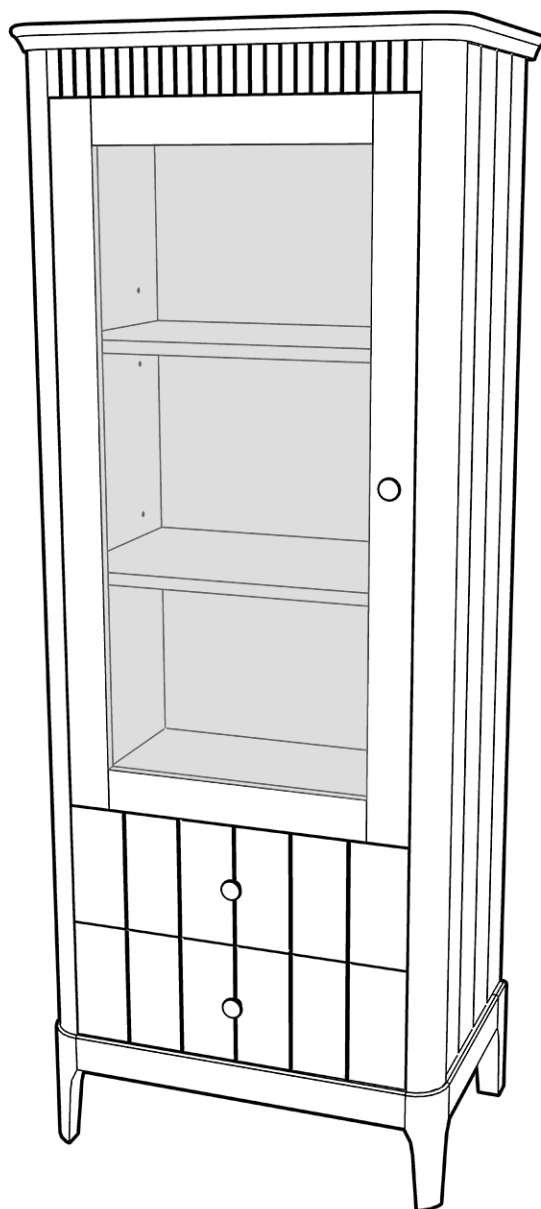

 **TIMBERICA**

RU Инструкция по сборке

EN Assembly instruction

FI Koontaohje



1006
54



2002
3



1038
28



1097
36



1096
36

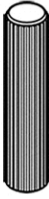

1004
10



1013
4

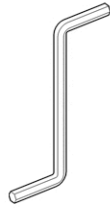

1034
1

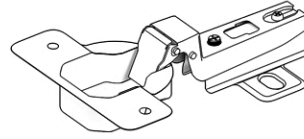

1024
2



1040
8



1039
10



1008
8

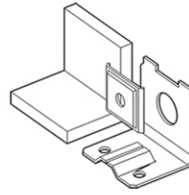

1099
2

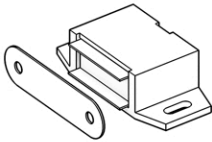

1042
1

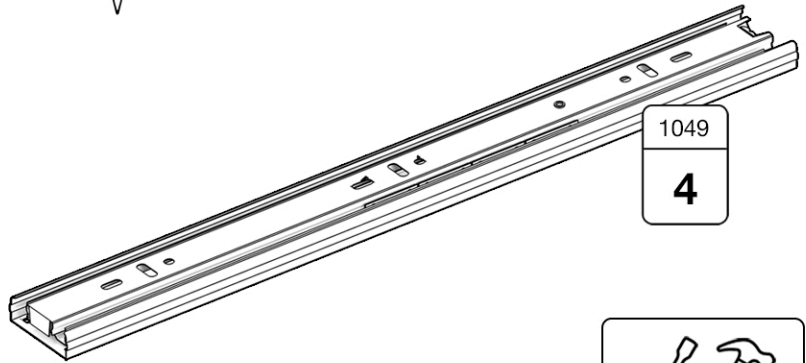

1049
4

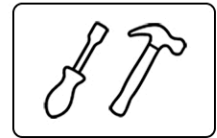

1

